

7346 TO 7370

(SHEET 1)

PARK MERCED

© COPYRIGHT SAN FRANCISCO
CITY & COUNTY ASSESSOR 1995

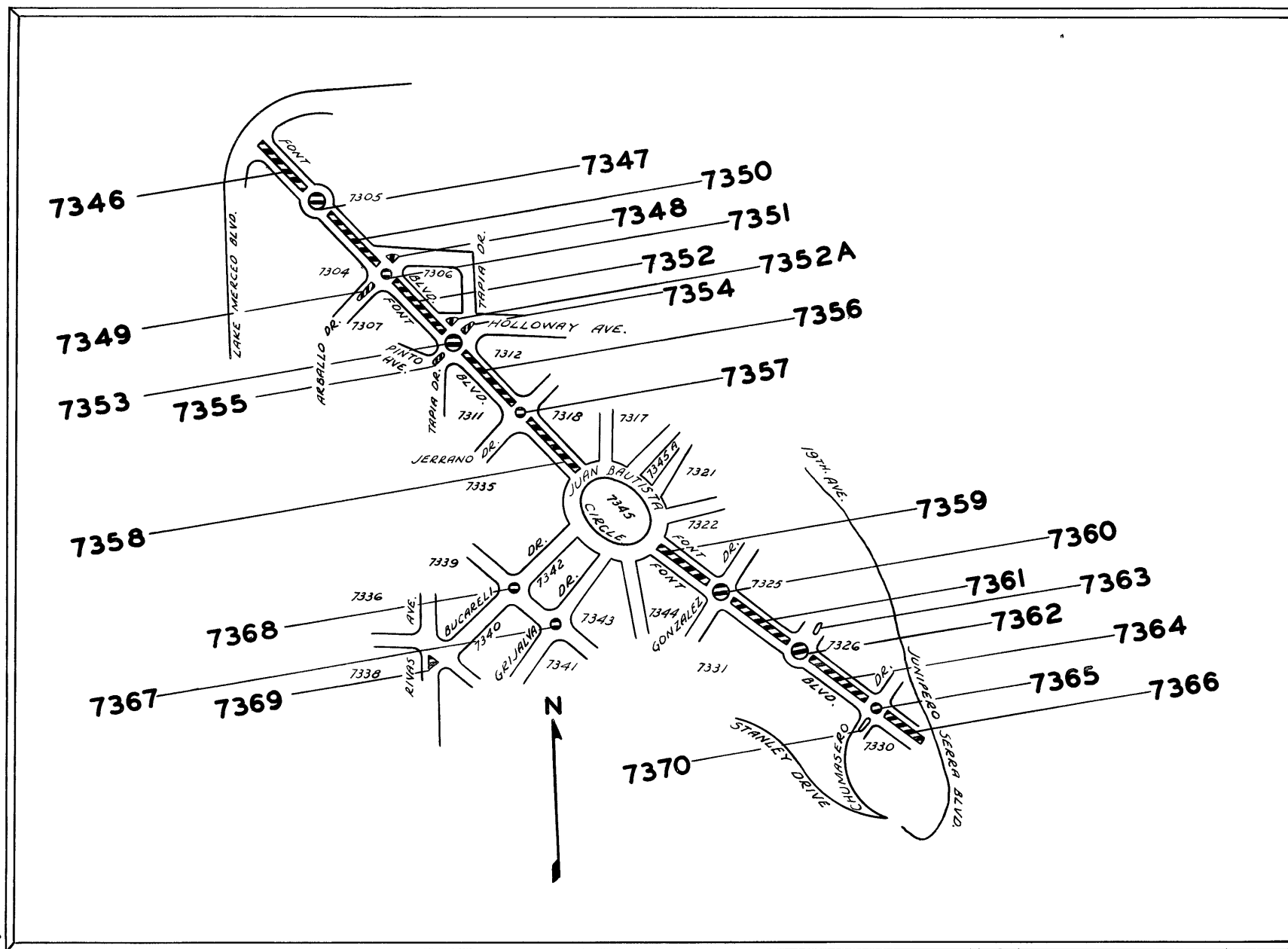

7346

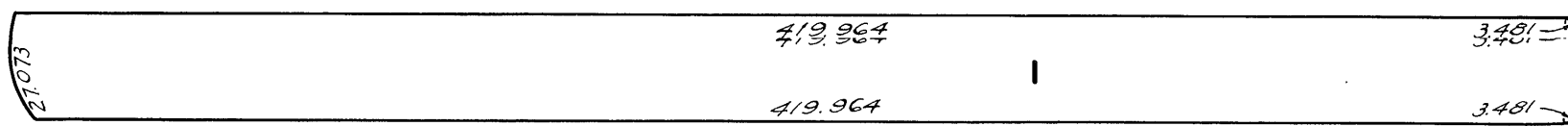

FONT

BLVD .

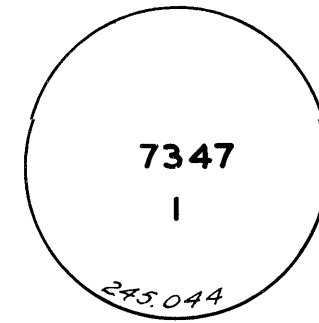

7348

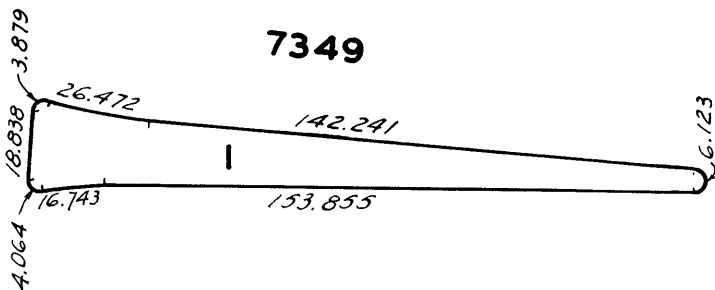
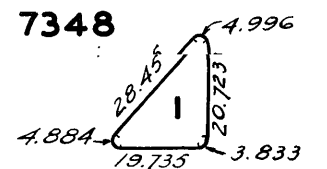

7349

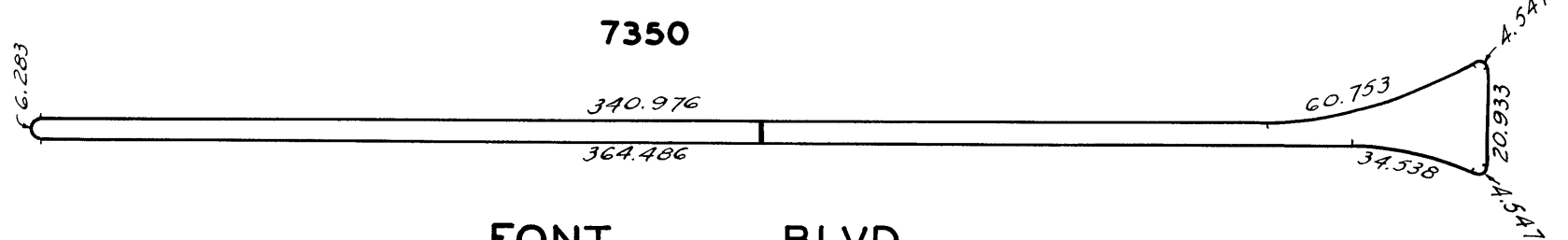

7350

FONT

BLVD .

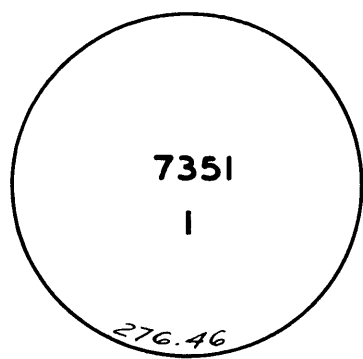

7351

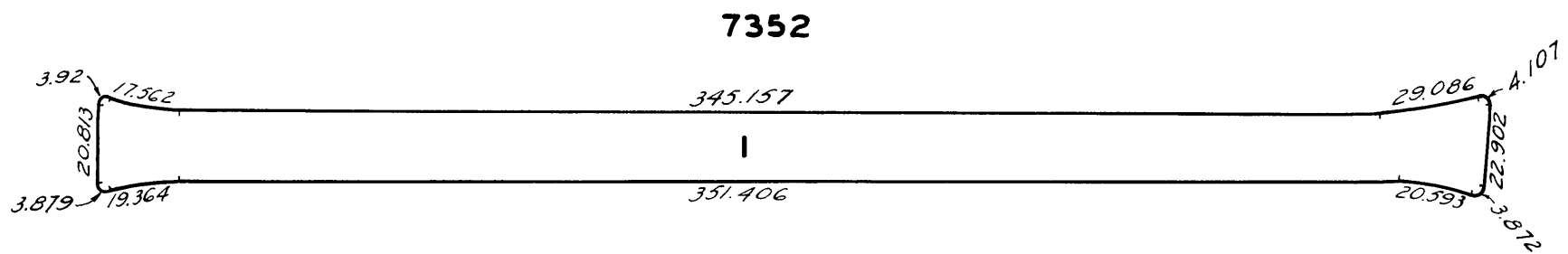

7352

FONT

BLVD .

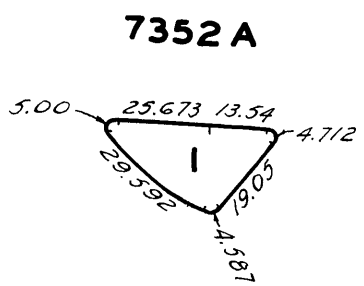

7352 A

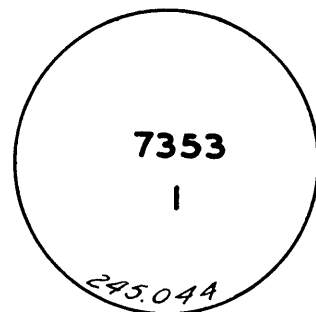

7353

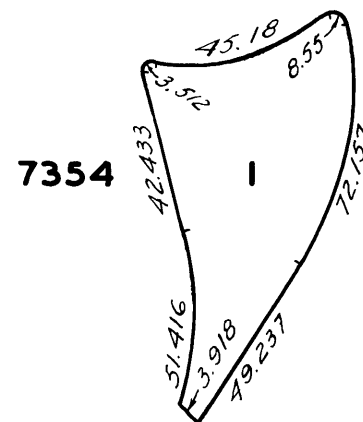

7354

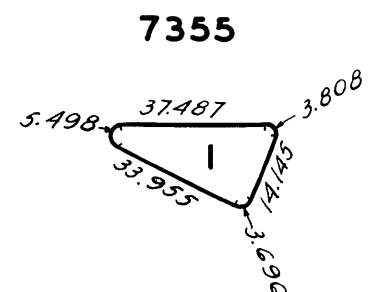

7355

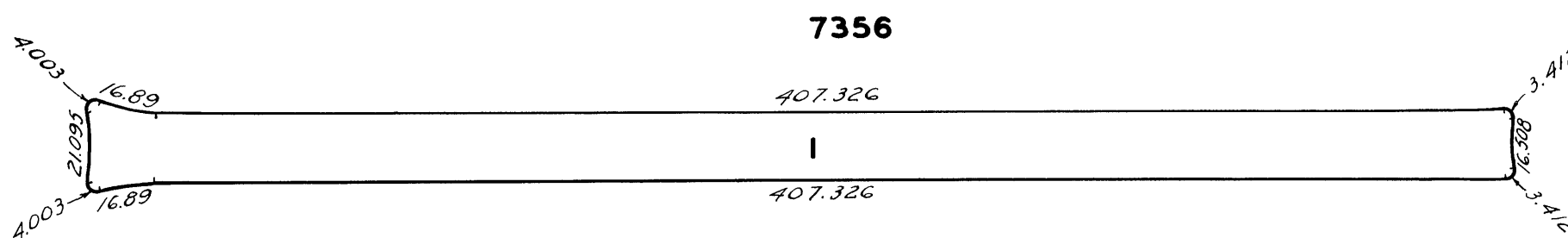

7356

FONT

BLVD .